

**LIAISON MODULES / ASSEMBLING MODULES / UNION MODULOS**

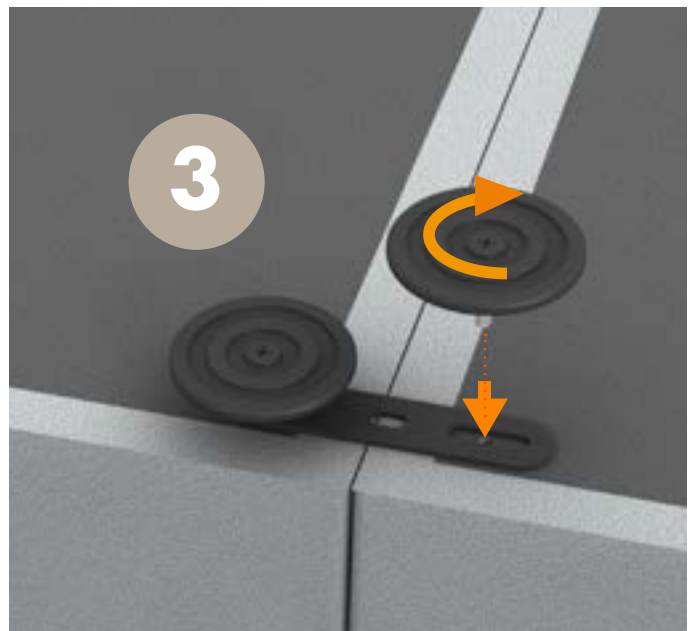

4

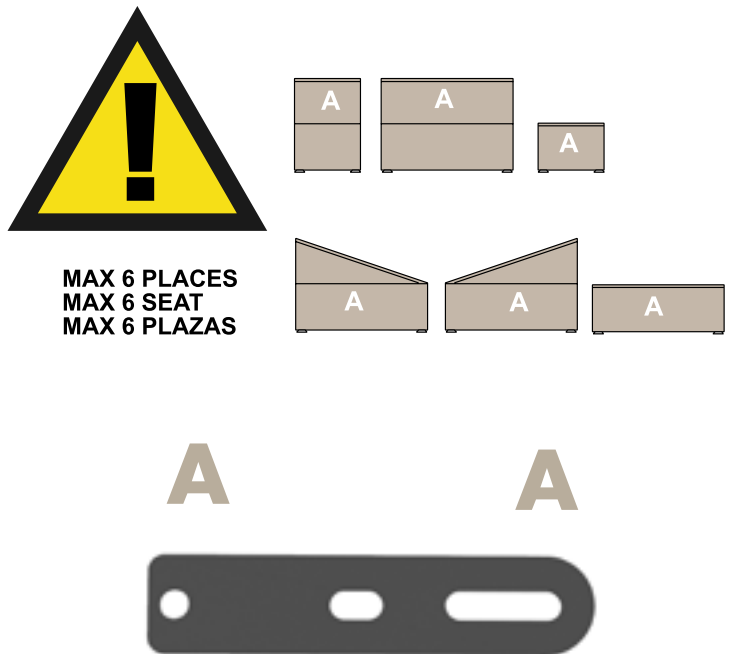

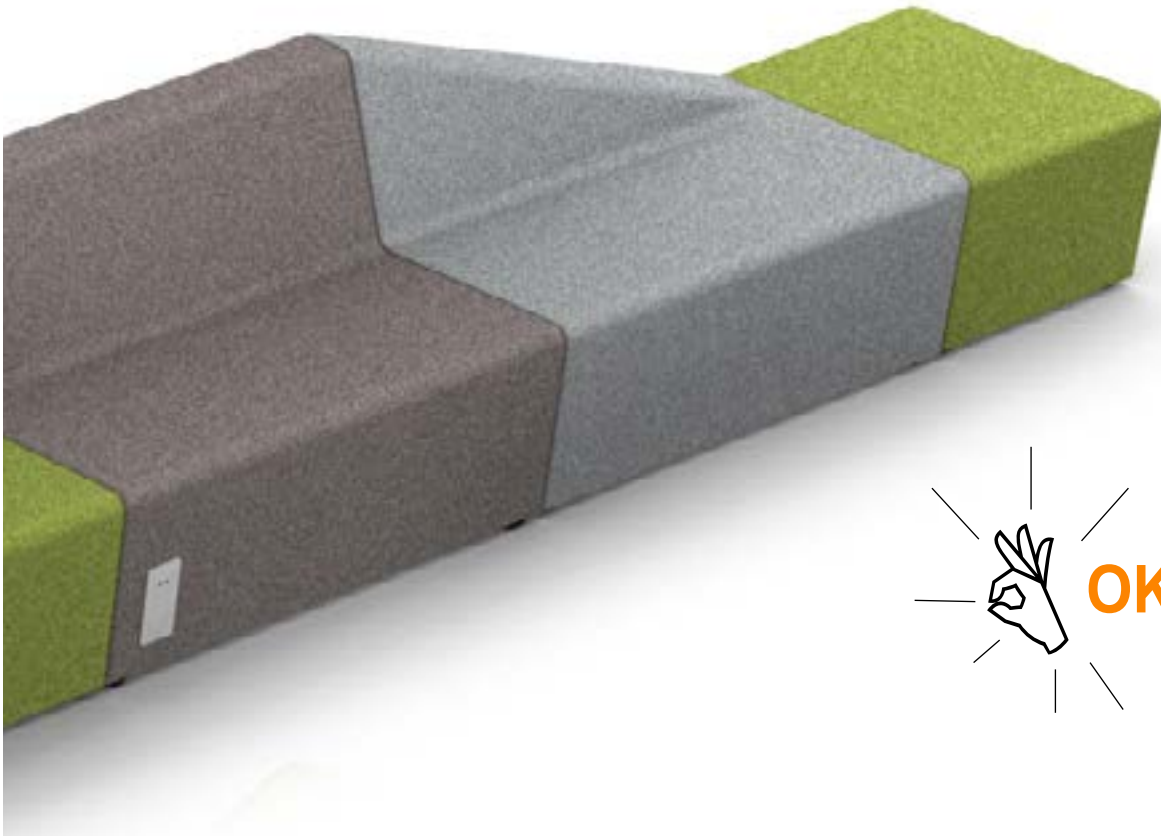
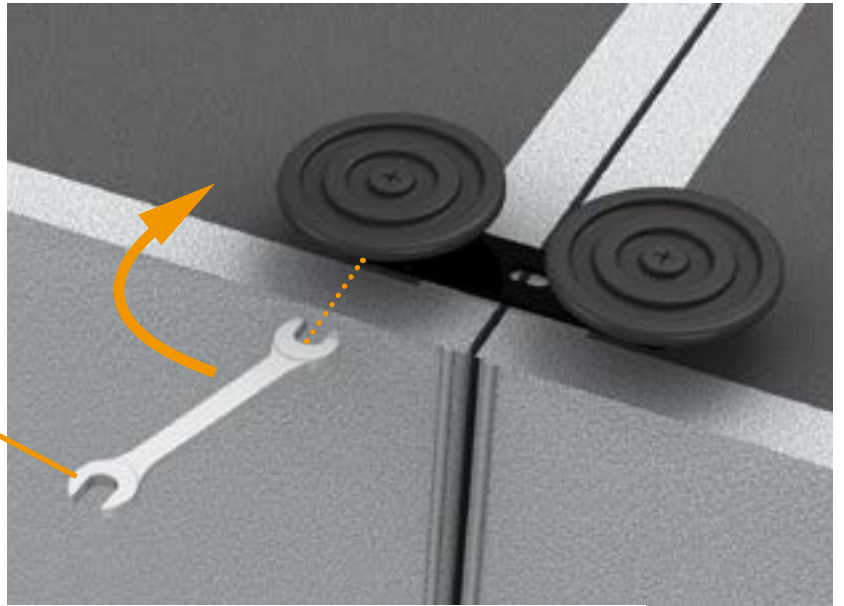
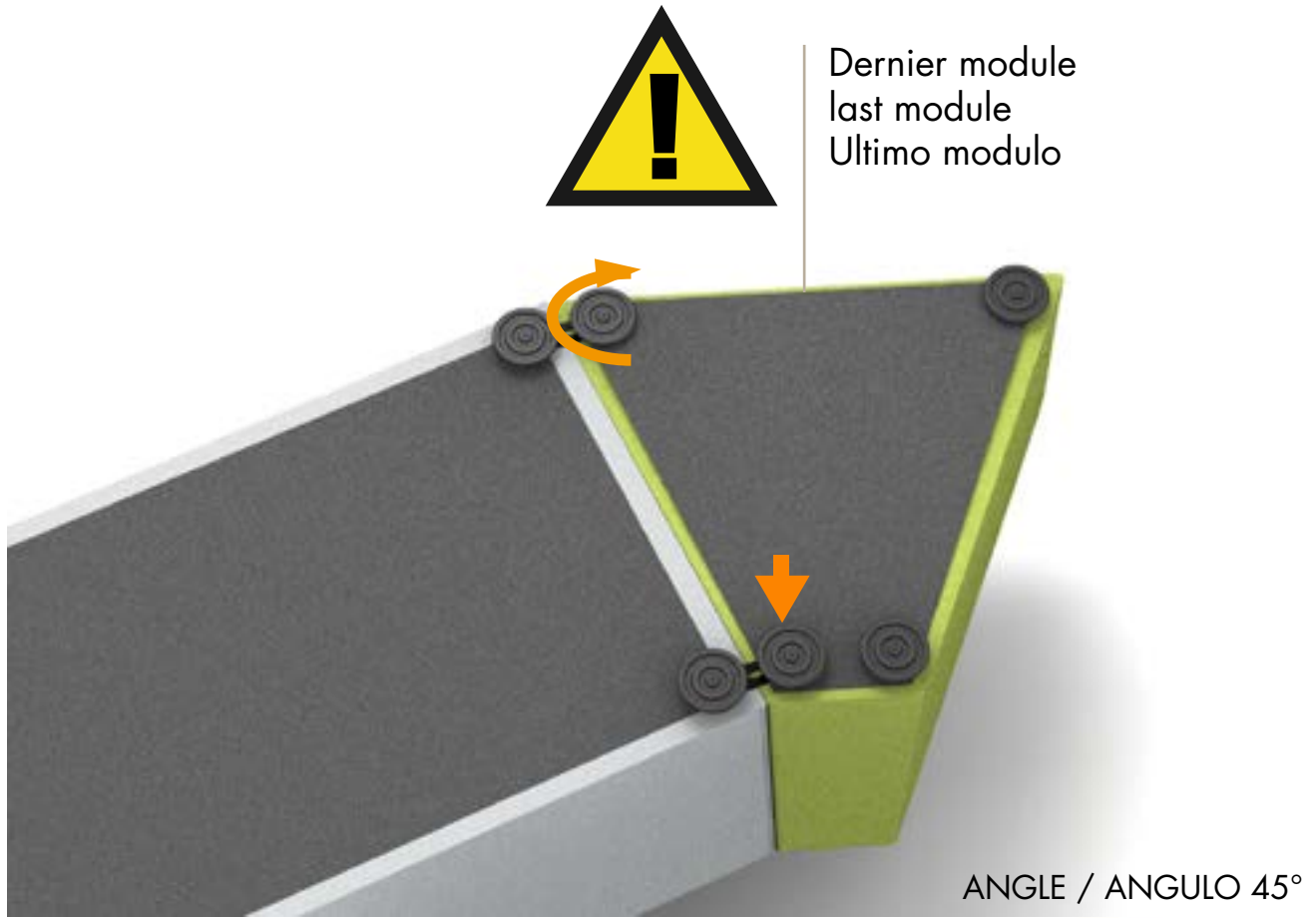

ANGLE / ANGULO 45°



Sokoa

## LIAISON MODULES ET FIXATION AU SOL ASSEMBLING AND GROUND FIXING UNION Y FIJACION AL SUELO

A

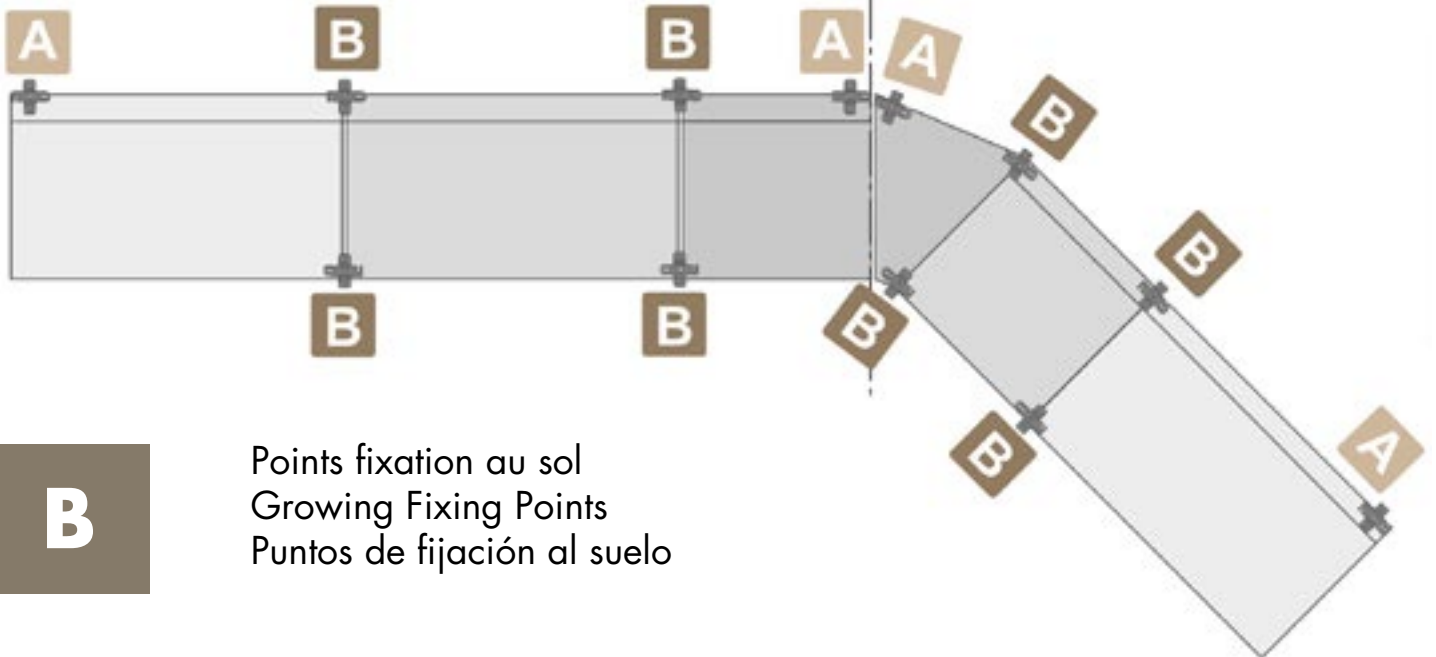
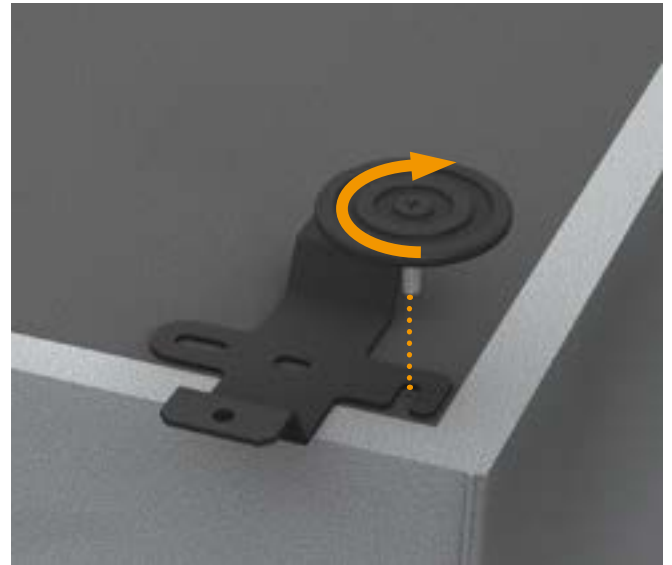

B

Points fixation au sol  
Growing Fixing Points  
Puntos de fijación al suelo

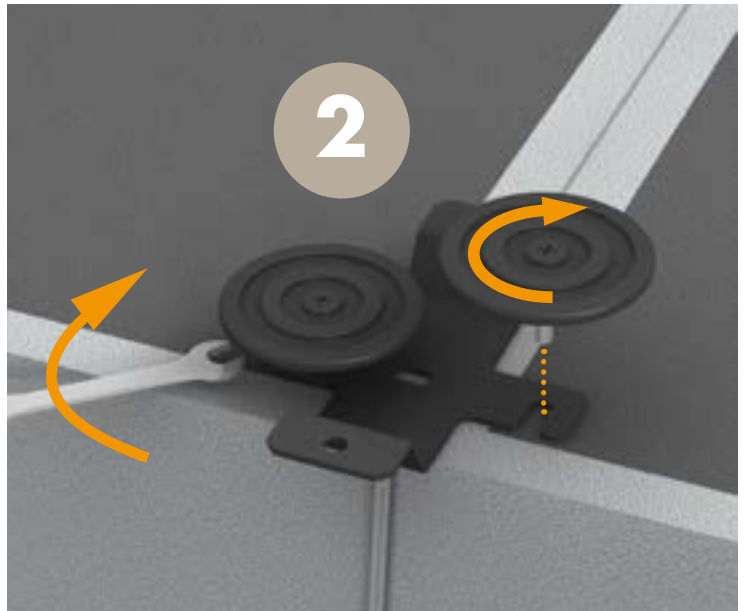
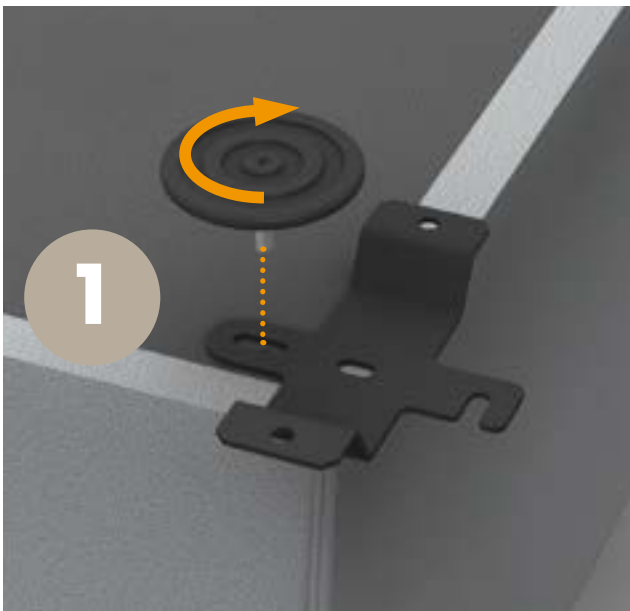



Montage - Assembling - Montaje

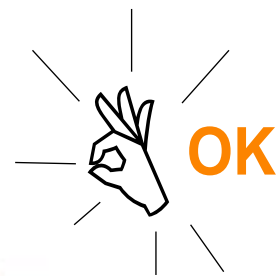
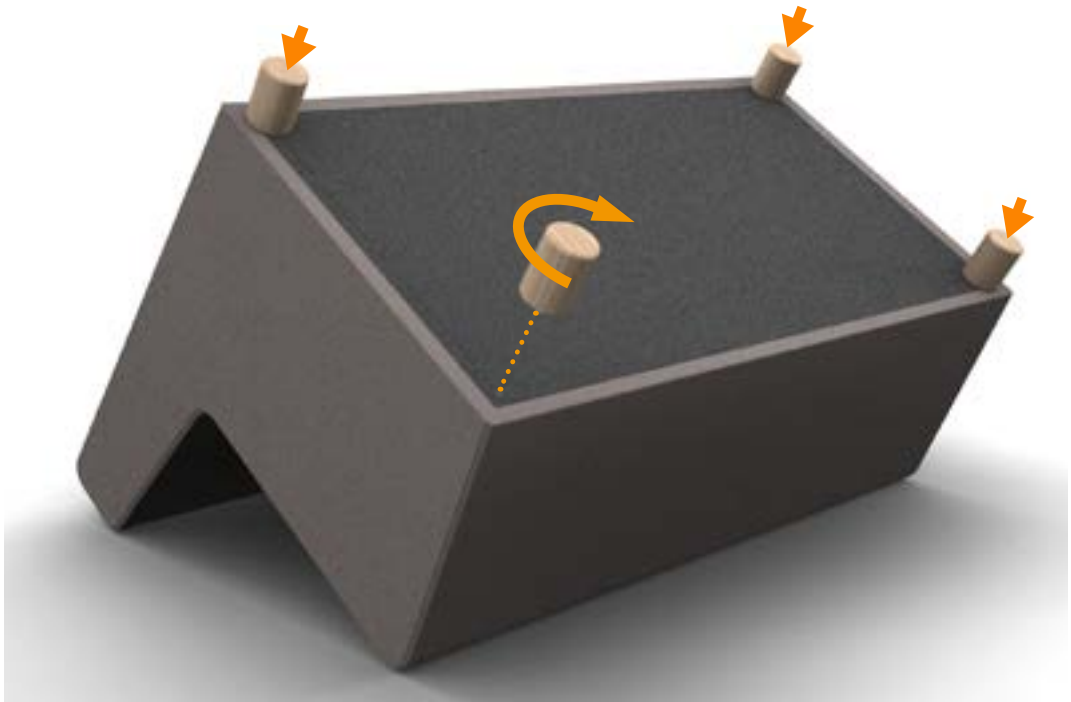

Sokoa

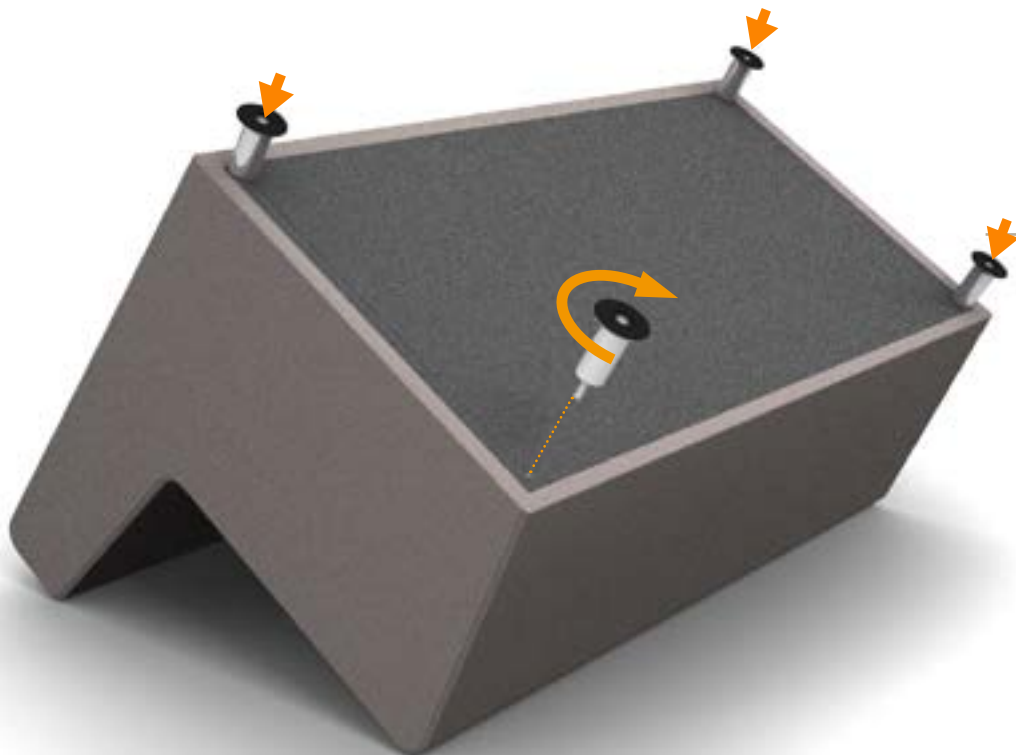







**A**

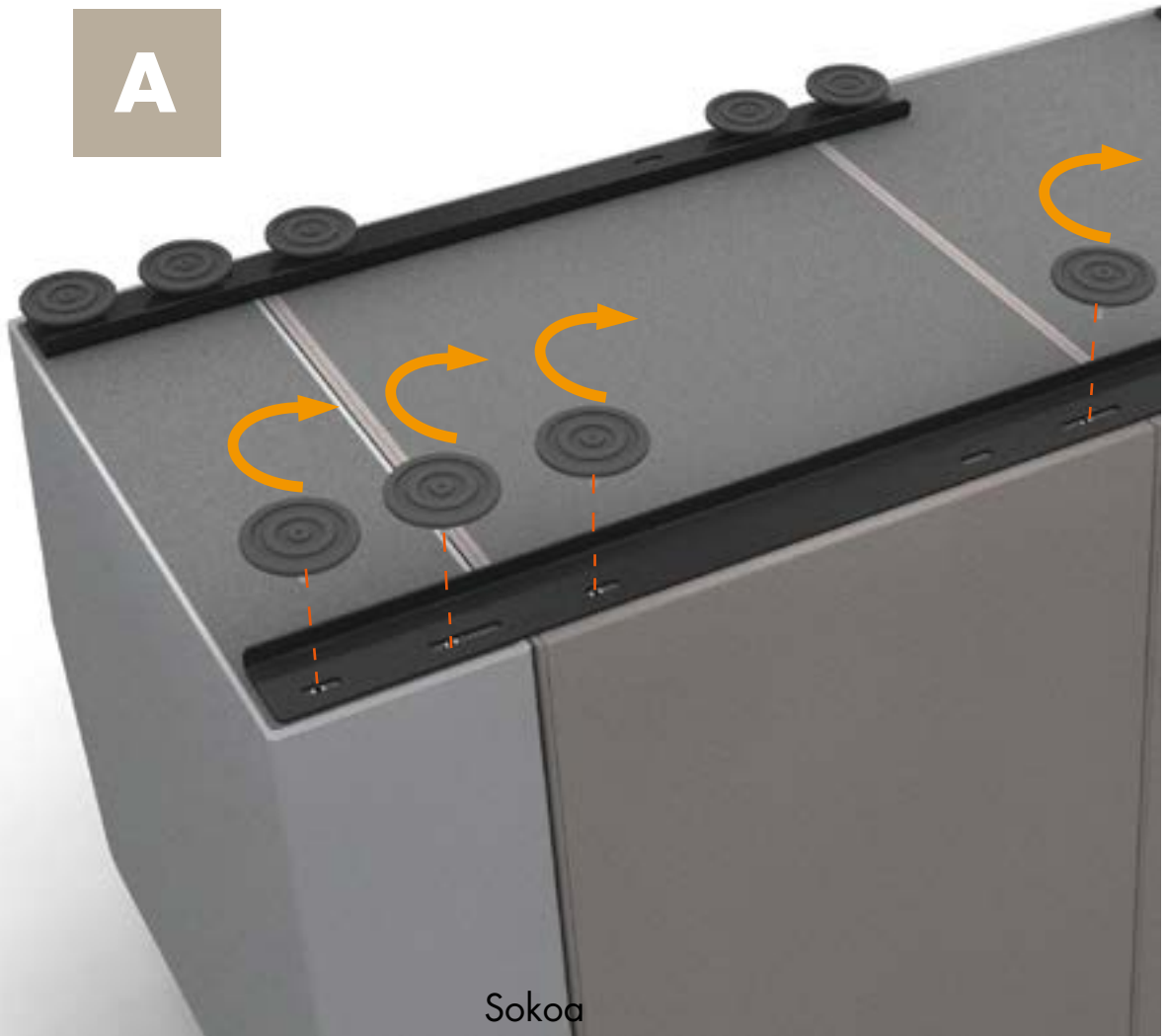

B

